

PR
electronics



5 3 3 4

**2-Wire Programmable
Transmitter**

No. 5334V108-UK

From ser. no. 141365001



ATEX



Revision Notes

The following list provides notes concerning revisions of this document.

Rev. ID	Date	Notes
108	13/45	IECEX and INMETRO approvals added

2-WIRE PROGRAMMABLE TRANSMITTER

PRETOP 5334

CONTENTS

Application.....	2
Technical characteristics.....	2
Mounting / installation	2
Applications.....	3
Order: 5334.....	4
Electrical specifications.....	4
Connections	7
Block diagram.....	8
Programming	9
Mechanical specifications	10
Mounting of sensor wires	10
Appendix.....	11
ATEX Installation Drawing - 5334A	12
ATEX Installation Drawing - 5334B	13
IECEX Installation Drawing - 5334A.....	15
IECEX Installation Drawing - 5334B.....	16
INMETRO Instruções de Segurança - 5334A.....	18
INMETRO Instruções de Segurança - 5334B.....	19

2-WIRE PROGRAMMABLE TRANSMITTER PRETOP 5334

- *TC input*
- *High measurement accuracy*
- *Galvanic isolation*
- *Programmable sensor error value*
- *For DIN form B sensor head mounting*

Application

- Linearised temperature measurement with TC sensor.
- Amplification of bipolar mV signals to a 4...20 mA signal, optionally linearised according to a defined linearisation function.

Technical characteristics

- Within a few seconds the user can program PR5334 to measure temperatures within all TC ranges defined by the norms.
- Cold junction compensation (CJC) with a built-in temperature sensor.
- Continuous check of vital stored data for safety reasons.

Mounting / installation

- For DIN form B sensor head mounting. In non-hazardous areas the 5334 can be mounted on a DIN rail with the PR fitting type 8421.
- **NB:** As Ex barrier for 5334B we recommend 5401B, 5114B, or 5116B.

APPLICATIONS

TC to 4...20 mA

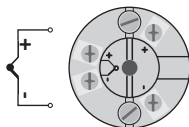

2-wire installation
in control room

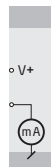

mV to 4...20 mA

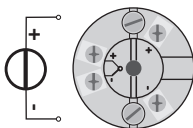

2-wire installation
in control room

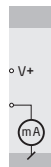

Order: 5334

Type	Version	Ambient temperature	Galvanic isolation
5334	Standard : A ATEX Ex, IECEx & INMETRO : B	-40°C...+85°C : 3	1500 VAC : B

Electrical specifications

Specifications range:

-40°C to +85°C

Common specifications:

Supply voltage, DC

Standard..... 7.2...35 V

ATEX Ex, IECEx & INMETRO 7.2...30 VDC

Internal consumption 25 mW...0.8 W

Voltage drop 7.2 VDC

Isolation voltage, test / operation..... 1.5 kVAC / 50 VAC

Warm-up time..... 5 min.

Communications interface Loop Link

Signal / noise ratio Min. 60 dB

Response time (programmable)..... 1...60 s

EEProm error check < 3.5 s

Signal dynamics, input..... 18 bit

Signal dynamics, output 16 bit

Calibration temperature 20...28°C

Accuracy, the greater of general and basic values:

General values		
Input type	Absolute accuracy	Temperature coefficient
All	≤ ±0.05% of span	≤ ±0.01% of span / °C

Basic values		
Input type	Basic accuracy	Temperature coefficient
Volt	$\leq \pm 10 \mu\text{V}$	$\leq \pm 1 \mu\text{V} / ^\circ\text{C}$
TC type: E, J, K, L, N, T, U	$\leq \pm 1^\circ\text{C}$	$\leq \pm 0.05^\circ\text{C} / ^\circ\text{C}$
TC type: B, R, S, W3, W5, LR	$\leq \pm 2^\circ\text{C}$	$\leq \pm 0.2^\circ\text{C} / ^\circ\text{C}$

EMC immunity influence	$< \pm 0.5\%$ of span
Extended EMC immunity: NAMUR NE 21, A criterion, burst	$< \pm 1\%$ of span

Effect of supply voltage variation	$< 0.005\%$ of span / VDC
Vibration	IEC 60068-2-6 Test FC
Lloyd's specification no. 1	4 g / 2...100 Hz
Max. wire size	1 x 1.5 mm ² stranded wire
Screw terminal torque	0.4 Nm
Humidity	$< 95\%$ RH (non-cond.)
Dimensions	$\varnothing 44 \times 20.2$ mm
Protection degree (enclosure / terminal)	IP68 / IP00
Weight	50 g

Electrical specifications, input:

Max. offset	50% of selec. max. value
-------------------	--------------------------

TC input:

Type	Min. temperature	Max. temperature	Min. span	Standard
B	+400°C	+1820°C	100°C	IEC584
E	-100°C	+1000°C	50°C	IEC584
J	-100°C	+1200°C	50°C	IEC584
K	-180°C	+1372°C	50°C	IEC584
L	-100°C	+900°C	50°C	DIN 43710
N	-180°C	+1300°C	50°C	IEC584
R	-50°C	+1760°C	100°C	IEC584
S	-50°C	+1760°C	100°C	IEC584
T	-200°C	+400°C	50°C	IEC584
U	-200°C	+600°C	50°C	DIN 43710
W3	0°C	+2300°C	100°C	ASTM E988-90
W5	0°C	+2300°C	100°C	ASTM E988-90
LR	-200°C	+800°C	50°C	GOST 3044-84

Cold junction compensation	< ±1.0°C
Sensor error detection.....	Yes
Sensor error current:	
When detecting.....	Nom. 33 mA
Else.....	0 mA

Voltage input:

Measurement range.....	-12...150 mV
Min. span	5 mV
Input resistance.....	10 MΩ

Output:

Current output:

Signal range	4...20 mA
Min. signal range.....	16 mA
Updating time	440 ms
Output signal at EEPROM error.....	≤ 3.5 mA
Load resistance.....	≤ (V _{supply} - 7.2) / 0.023 [Ω]
Load stability.....	< ±0.01% of span / 100 Ω

Sensor error detection:

Programmable	3.5...23 mA
Namur NE43 Upscale.....	23 mA
Namur NE43 Downscale.....	3.5 mA

Of span = Of the presently selected range

Approvals:

EMC 2004/108/EC	EN 61326-1
GOST R	

Marine approval:

Det Norske Veritas, Ships & Offshore Standard for Certification No. 2.4

Ex:

ATEX 94/9/EC	
5334A.....	KEMA 10ATEX0002 X
5334B.....	KEMA 06ATEX0062 X
IECEX	DEK 13.0035X
INMETRO	DEKRA 13.0001 X
GOST Ex	

CONNECTIONS

Input:

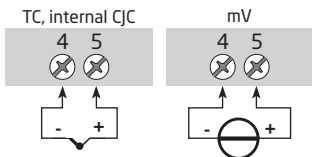

Output:

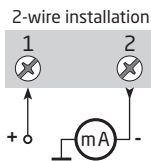

BLOCK DIAGRAM

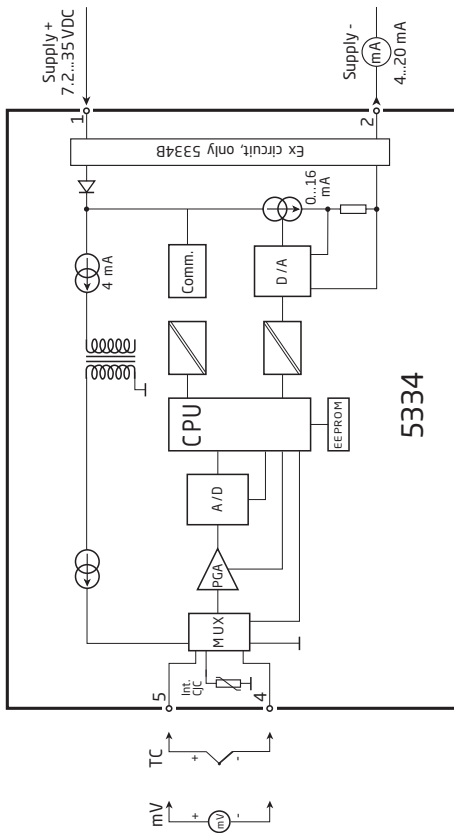

PROGRAMMING

- Loop Link is a communications interface that is needed for programming PReTop 5334.
- For programming please refer to the drawing below and the help functions in PReset.
- Loop link is not approved for communication with modules installed in hazardous (Ex) areas.

Order: Loop Link

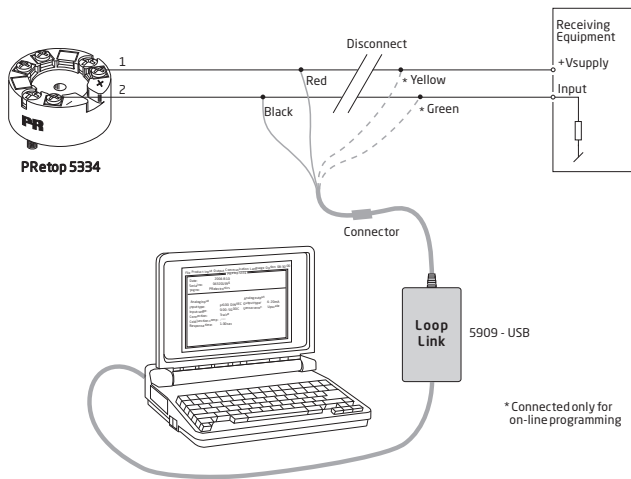

Mechanical specifications

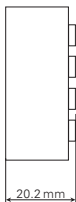
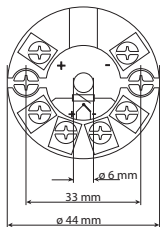

Mounting of sensor wires

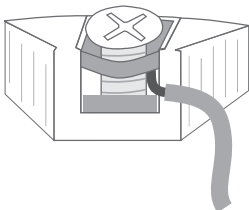

Wires must be mounted between the metal plates.

APPENDIX

ATEX INSTALLATION DRAWING - 5334A

ATEX INSTALLATION DRAWING - 5334B

IECE_x INSTALLATION DRAWING - 5334A

IECE_x INSTALLATION DRAWING - 5334B

INMETRO INSTRUÇÕES DE SEGURANÇA - 5334A

INMETRO INSTRUÇÕES DE SEGURANÇA - 5334B

ATEX Installation drawing

For safe installation of 5331A3B or 5334A3B the following must be observed. The module shall only be installed by qualified personnel who are familiar with the national and international laws, directives and standards that apply to this area.

Year of manufacture can be taken from the first two digits in the serial number.

ATEX Certificate KEMA 10ATEX 0002 X

Marking

	<p>II 3 G Ex nA [ic] IIC T4 ... T6 Gc II 3 G Ex ic IIC T4...T6 Gc II 3 D Ex ic IIIC Dc</p>
---	--

Standards EN 60079-0 : 2012, EN 60079-11 : 2012, EN 60079-15 : 2010

<p>T4: $-40 \leq T_a \leq 85^{\circ}\text{C}$ T6: $-40 \leq T_a \leq 60^{\circ}\text{C}$</p>	<p>Terminal: 3,4,5,6 Ex nA [ic]</p> <p>Uo: 9.6 V Io: 25 mA Po: 60 mW Lo: 33 mH Co: 2.4 μF</p>	<p>Terminal: 1,2 Ex nA</p> <p>Umax \leq 35 VDC</p>	<p>Terminal: 1,2 Ex ic</p> <p>Ui = 35 VDC Ii = 110 mA Li = 10 μH Ci = 1.0 nF</p>
---	---	---	---

Special conditions for safe use.

For type of protection Ex nA, the transmitter shall be mounted in a metal enclosure providing a degree of protection of at least IP54 according to EN60529.

For use in the presence of combustible dusts the transmitter shall be mounted in an enclosure providing a degree of protection of at least IP6X in accordance with EN60529, the surface temperature of the outer enclosure is 20 K above the ambient temperature.

For an ambient temperature $\geq 60^{\circ}\text{C}$, heat resistant cables shall be used with a rating of at least 20 K above the ambient temperature.

ATEX Installation drawing



For safe installation of 5331D or 5334B the following must be observed. The module shall only be installed by qualified personnel who are familiar with the national and international laws, directives and standards that apply to this area.

Year of manufacture can be taken from the first two digits in the serial number.

ATEX Certificate KEMA 06ATEX 0062 X

Marking  II 1 G Ex ia IIC T4...T6 Ga
II 1 D Ex ia IIIC Da
II 1 M Ex ia I Ma

Standards EN 60079-0 : 2012, EN 60079-11 : 2012, EN 60079-26 : 2007,
EN 60079-15 :2010

Hazardous area

Zone 0, 1, 2, 20, 21, 22

T4: $-40 \leq T_a \leq 85^\circ\text{C}$

T6: $-40 \leq T_a \leq 60^\circ\text{C}$

Terminal: 3,4,5,6

Uo: 9.6 VDC

Io: 25 mA

Po: 60 mW

Lo: 33 mH

Co: 2.4 μ F

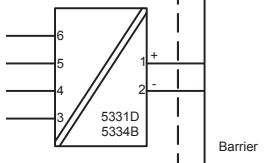

Terminal: 1,2

Ui: 30 VDC

Ii: 120 mA

Pi: 0.84 W

Li: 10 μ H

Ci: 1.0 nF

Installation notes.

The sensor circuit is not infallibly galvanic isolated from the input circuit. However, the galvanic isolation between the circuits is capable of withstanding a test voltage of 500Vac during 1 minute.

In a potentially explosive gas atmosphere, the transmitter shall be mounted in an enclosure in order to provide a degree of protection of at least IP20 according to EN60529.

If the transmitter is installed in an explosive atmosphere requiring the use of equipment of category 1 G, 1 M or 2 M, and if the enclosure is made of aluminum, it must be installed such, that ignition sources due to impact and friction sparks are excluded.

if the enclosure is made of non-metallic materials, electrostatic charging shall be avoided.

For installation in a potentially explosive dust atmosphere, the following instructions apply:

The transmitter shall be mounted in a metal enclosure form B according to DIN43729 that is providing a degree of protection of at least IP6X according to EN60529, that is suitable for the application and correctly installed.

Cable entries and blanking elements shall be used that are suitable for the application and correctly installed.

For an ambient temperature $\geq 60^{\circ}\text{C}$, heat resistant cables shall be used with a rating of at least 20 K above the ambient temperature.

The surface temperature of the enclosure is equal to the ambient temperature plus 20 K, for a dust layer with a thickness up to 5 mm

IECEx Installation drawing



For safe installation of 5331A or 5334A the following must be observed. The module shall only be installed by qualified personnel who are familiar with the national and international laws, directives and standards that apply to this area.
Year of manufacture can be taken from the first two digits in the serial number.

Certificate	IECEx DEK 13.0035X
Marking	Ex nA [ic] IIC T4..T6 Gc Ex ic IIC T4..T6 Gc Ex ic IIIC Dc
Standards	IEC 60079-0 : 2011, IEC 60079-11 : 2011, IEC 60079-15 : 2010

T4: $-40 \leq T_a \leq 85^\circ\text{C}$
T6: $-40 \leq T_a \leq 60^\circ\text{C}$

Terminal: 3,4,5,6

Uo: 9.6 V
Io: 25 mA
Po: 60 mW
Lo: 33 mH
Co: 2.4 μF

Terminal: 1,2

Ex nA
Umax = 35 VDC

Terminal: 1,2

Ex ic
Ui = 35 VDC
Ii = 110 mA
Li = 10 μH
Ci = 1.0 nF

Installation note:

For installation in a potentially explosive gas atmosphere, the following instructions apply:
For nA installation the transmitter must be installed in a metal enclosure, e.g. a form B enclosure providing a degree of protection of at least IP54 according to IEC60529 or in an enclosure with type of protection Ex n or Ex e.

For ic installation the transmitter must be installed in enclosure providing a degree of protection of at least IP20 according to IEC60529 and that is suitable for the application.

Cable entry devices and blanking elements shall fulfill the same requirements
For an ambient temperature $\geq 60^\circ\text{C}$, heat resistant cables shall be used with a rating of at least 20 K above the ambient temperature.

For installation in a potentially explosive dust atmosphere, the following instructions apply:
The surface temperature of the enclosure is equal to the ambient temperature plus 20 K, for a dust layer with a thickness up to 5 mm.
The transmitter must be mounted in a enclosure according to DIN 43729 that provides a degree of protection of at least IP6X according to IEC60529, and that is suitable for the application. Cable entry devices and blanking elements shall fulfill the same requirements.

IECEx Installation drawing



For safe installation of 5331D or 5334B the following must be observed. The module shall only be installed by qualified personnel who are familiar with the national and international laws, directives and standards that apply to this area.

Year of manufacture can be taken from the first two digits in the serial number.

Certificate	IECEx DEK 13.0035X
Marking	Ex ia IIC T4...T6 Ga Ex ia IIIC Da Ex ia I Ma
Standards	IEC 60079-0 : 2011, IEC 60079-11 : 2011, IEC 60079-26:2006

Hazardous area

Zone 0, 1, 2, 20, 21, 22, M1

T4: $-40 \leq T_a \leq 85^\circ\text{C}$

T5: $-40 \leq T_a \leq 60^\circ\text{C}$

T6: $-40 \leq T_a \leq 45^\circ\text{C}$

Terminal: 3,4,5,6

Uo: 9.6 VDC

Io: 25 mA

Po: 60 mW

Lo: 33 mH

Co: 2.4 μF

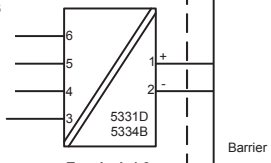

Terminal: 1,2

Ui: 30 VDC

Ii: 120 mA

Pi: 0.84 W

Li: 10 μH

Ci: 1.0 nF

Installation notes.

The sensor circuit is not infallibly galvanic isolated from the input circuit. However, the galvanic isolation between the circuits is capable of withstanding a test voltage of 500Vac during 1 minute.

In a potentially explosive gas atmosphere, the transmitter shall be mounted in a metal form B enclosure in order to provide a degree of protection of at least IP20 according to IEC60529. If however the environment requires a higher degree of protection, this shall be taken into account.

If the transmitter is installed in an explosive atmosphere requiring the use of equipment protection level Ga, Ma and Mb, and if the enclosure is made of aluminum, it must be installed such, that ignition sources due to impact and friction sparks are excluded.

For installation in a potentially explosive dust atmosphere, the following instructions apply:

For explosive dust atmospheres, the surface temperature of the outer enclosure is 20 K above the ambient temperature.

The transmitter shall be mounted in a metal enclosure form B according to DIN43729 that is providing a degree of protection of at least IP6X according to IEC60529, that is suitable for the application and correctly installed.

Cable entries and blanking elements shall be used that are suitable for the application and correctly installed.

For an ambient temperature $\geq 60^{\circ}\text{C}$, heat resistant cables shall be used with a rating of at least 20 K above the ambient temperature.

Desenho de Instalação INMETRO



Para instalação segura do 5331A ou 5334A o seguinte deve ser observado. O modo deve apenas ser instalado por pessoas qualificadas que são familiarizadas com as leis nacionais e internacionais, diretrizes e padrões que se aplicam a esta área.

Ano de fabricação pode ser pego dos dois primeiros dígitos do número de série.

Certificado	DEKRA 13.0001 X
Indicação	Ex nA [ic] IIC T4..T6 Gc Ex ic IIC T4..T6 Gc Ex ic IIIC Dc

Padrões ABNT NBR IEC 60079-0 : 2008, ABNT NBR IEC 60079-11 : 2009,
IEC 60079-15 : 2010, ABNT NBR IEC 60079-26 : 2008

T4: $-40 \leq T_a \leq 85^\circ\text{C}$	Terminal: 3,4,5,6	Terminal: 1,2	Terminal: 1,2
T6: $-40 \leq T_a \leq 60^\circ\text{C}$	Uo: 9,6 V	Ex nA	Ex ic
	Io: 25 mA		
	Po: 60 mW	Umax =35 VDC	Ui = 35 VDC
	Lo: 33 mH		Ii = 110 mA
	Co: 2,4 μF		Li = 10 μH
			Ci = 1,0 nF

Notas para instalação

Para a instalação em uma atmosfera de gás potencialmente explosivo, se aplicam as instruções a seguir:

Para a instalação nA o transmissor deve ser instalado em um gabinete de metal, por exemplo, gabinete em forma B que forneça um grau de proteção de pelo menos IP54 de acordo com IEC60529 ou em um caixa com tipo de proteção Ex n ou Ex e.

Para a instalação IC o transmissor deve ser instalado em um invólucro proporcionando um grau de proteção de IP20, pelo menos, de acordo com a norma IEC60529 que é adequado para a aplicação.

Dispositivos de entrada de cabos e elementos de supressão devem cumprir os mesmos requisitos.

Para uma temperatura ambiente $\geq 60^\circ\text{C}$, os cabos resistentes ao calor precisam ser utilizados com uma classificação de pelo menos 20 K acima da temperatura ambiente.

Para a instalação em uma atmosfera de poeira potencialmente explosiva, se aplicam as instruções a seguir:

A temperatura da superfície do invólucro é igual à temperatura ambiente mais 20 K, para uma camada de pó, com uma espessura superior a 5 mm.

O transmissor deve ser montado em um invólucro de acordo com a norma DIN 43729, que proporciona um grau de proteção de, pelo menos, IP6X de acordo com a norma IEC60529, e que seja apropriado para a aplicação.

Dispositivos de entrada de cabos e elementos de supressão devem cumprir as mesmas exigências.

Desenho de Instalação INMETRO



Para instalação segura do 5331D ou 5334B o seguinte deve ser observado. O modo deve apenas ser instalado por pessoas qualificadas que são familiarizadas com as leis nacionais e internacionais, diretrizes e padrões que se aplicam a esta área.
Ano de fabricação pode ser pego dos dois primeiros dígitos do número de série.

CertificadoDEKRA 13.0001 X

Indicação Ex ia IIC T6...T4 Ga
Ex ia IIIC Da

Padrões ABNT NBR IEC 60079-0 : 2008 ABNT NBR IEC 60079-11 : 2009 IEC 60079-15 : 2010
ABNT NBR IEC 60079-26 : 2008

Áreas Perigosas

Zona 0, 1, 2, 20, 21, 22,

T4: $-40 \leq T_a \leq 85^\circ\text{C}$

T5: $-40 \leq T_a \leq 60^\circ\text{C}$

T6: $-40 \leq T_a \leq 45^\circ\text{C}$

Terminal: 3,4,5,6

Uo: 9,6 VDC

Io: 25 mA

Po: 60 mW

Lo: 33 mH

Co: 2,4 μF

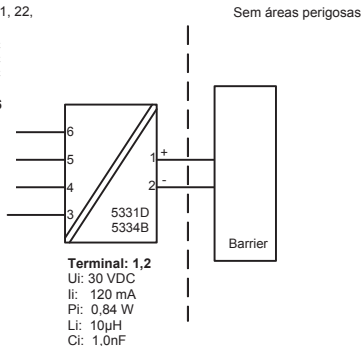

Notas de instalação

O circuito do sensor não é isolado galvanicamente infalível do circuito de entrada. Contudo, a isolação galvânica entre os circuitos é capaz de resistir a um teste de tensão de 500Vac durante 1 minuto.

Em uma atmosfera de gás potencialmente explosiva, o transmissor deve ser montado em um enclosure a fim de garantir um grau de proteção de no mínimo IP20 de acordo com EN60529. Se contudo o ambiente requer um nível de proteção maior, isso deve ser levado em conta

Se o transmissor é instalado em uma atmosfera explosiva exigindo o uso de equipamento de categoria Ga e se o enclosure é feito de alumínio, ele deve ser instalado de modo que, mesmo em caso de avaria rara, fontes de ignição devido a impacto e fricção, faíscas são eliminadas; se o enclosure é feito de materiais não metálicos, cargas eletroestáticas devem ser evitadas.

Para instalação em atmosfera de poeira potencialmente explosiva, as instruções a seguir:

O transmissor deve ser montado em enclosure de metal forma B de acordo com DIN43729 que está fornecendo um grau de proteção de pelo menos IP6X de acordo com EN60529. Isso é adequado para aplicação e corretamente instalado.

As entradas dos cabos e os elementos de obturação que podem ser utilizados são adequados para a aplicação e corretamente instalados.

Para temperatura ambiente $\geq 60^{\circ}\text{C}$, fios de resistência ao calor devem ser usados com uma faixa de pelo menos 20K acima da temperatura ambiente.

A temperatura da superfície do enclosure é igual à temperatura ambiente mais de 20 K, por uma camada de pó, com uma espessura até 5 mm.



Displays Programmable displays with a wide selection of inputs and outputs for display of temperature, volume and weight, etc. Feature linearisation, scaling, and difference measurement functions for programming via PReset software.



Ex interfaces Interfaces for analogue and digital signals as well as HART® signals between sensors / I/P converters / frequency signals and control systems in Ex zone 0, 1 & 2 and for some devices in zone 20, 21 & 22.



Isolation Galvanic isolators for analogue and digital signals as well as HART® signals. A wide product range with both loop-powered and universal isolators featuring linearisation, inversion, and scaling of output signals.



Temperature A wide selection of transmitters for DIN form B mounting and DIN rail devices with analogue and digital bus communication ranging from application-specific to universal transmitters.



Universal PC or front programmable devices with universal options for input, output and supply. This range offers a number of advanced features such as process calibration, linearisation and auto-diagnosis.





www.preelectronics.fr
sales@preelectronics.fr



www.preelectronics.de
sales@preelectronics.de



www.preelectronics.es
sales@preelectronics.es



www.preelectronics.it
sales@preelectronics.it



www.preelectronics.se
sales@preelectronics.se



www.preelectronics.com
sales@preelectronics.com



www.preelectronics.com
sales@preelectronics.com



www.preelectronics.cn
sales@preelectronics.cn

Head office

Denmark
PR electronics A/S
Lerbakken 10
DK-8410 Rønede

www.preelectronics.com
sales@preelectronics.dk
tel. +45 86 37 26 77
fax +45 86 37 30 85



QUALITY SYSTEM AND ENVIRONMENTAL MANAGEMENT SYSTEM
DS/EN ISO 9001
DS/EN ISO 14001

